

LH18-12 12V18Ah

Specifications

Nominal Voltage	12V	
Rated capacity (20 hour rate)	18Ah	
Dimensions	Length	181±2mm(7.13inch)
	Width	77±1mm(3.03inch)
	Height	167±2mm(6.57inch)
	Total Height	167±2mm(6.57inch)
Approx. Weight	5.2kg(11.5lbs)±4%	

Outer dimensions (mm)

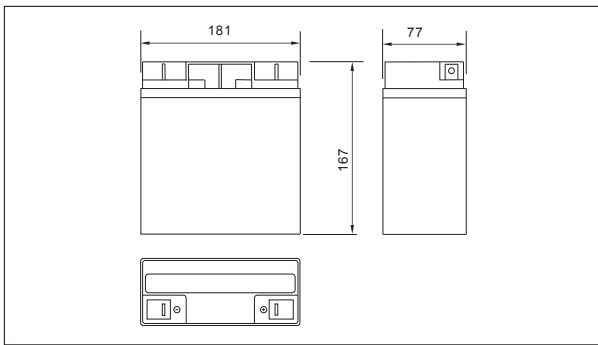

Terminal Type (mm)

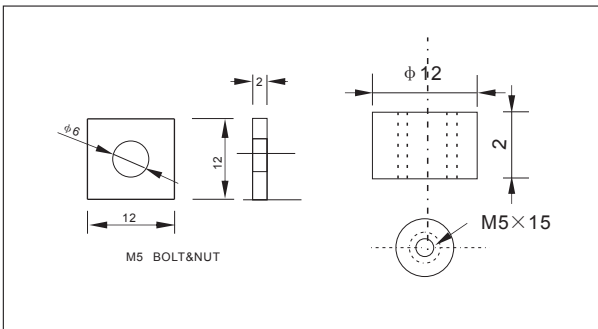

Construction

Component	Positive plate	Negative plate	Container	Cover	Separator	Electrolyte	Safety valve	Terminal
Raw material	Lead dioxide	Lead	ABS	ABS	AGM	Sulfuric acid	Rubber	Copper

Constant Current Discharge Characteristics Unit:A(25°C,77°F)

F.V/Time	5min	10min	15min	30min	60min	2h	3h	4h	5h	10h	20h
9.60V	68.8	43.6	34.0	19.2	11.8	6.45	4.46	3.69	3.14	1.70	0.91
9.90V	66.7	42.3	33.2	18.8	11.6	6.41	4.44	3.67	3.12	1.70	0.91
10.2V	63.9	40.5	32.0	18.2	11.3	6.35	4.40	3.64	3.10	1.69	0.91
10.5V	61.2	38.8	30.9	17.8	11.1	6.26	4.37	3.62	3.08	1.68	0.90
10.8V	57.8	36.6	29.3	17.1	10.8	6.10	4.24	3.51	2.99	1.65	0.88

Constant Power Discharge Characteristics Unit:W(25°C,77°F)

F.V/Time	5min	10min	15min	30min	60min	2h	3h	4h	5h	10h	20h
9.60V	767	491	388	220	137	75.5	53.0	44.0	37.5	20.5	11.0
9.90V	744	477	379	215	134	75.0	52.7	43.7	37.3	20.4	10.9
10.2V	714	457	365	209	131	74.3	52.3	43.4	37.0	20.3	10.9
10.5V	683	437	352	204	128	73.2	52.0	43.1	36.8	20.2	10.8
10.8V	645	413	334	196	125	71.4	50.4	41.8	35.6	19.7	10.6

Note: The above characteristics data can be obtained within three charge or discharge cycles.



Characteristics

Capacity (25°C)	20HR(10.5V)	18Ah
	10HR(10.5V)	16.8Ah
	1HR(9.60V)	11Ah
Terminal type		T3/T12
Internal resistance (Fully charged, 25°C)		Approx. 15m Ω
Capacity affected by temperature (20HR)	40°C	102%
	25°C	100%
	0°C	85%
	-15°C	65%
Self-discharge (25°C)	3month	Remaining Capacity:91%
	6month	Remaining Capacity:82%
	12month	Remaining Capacity:65%
Nominal operating temperature		25°C ±3°C(77°F ±5°F)
Operating temperature range	Discharge	-15°C~50°C(5°F~122°F)
	Charge	-10°C~50°C(14°F~122°F)
	Storage	-20°C~50°C(-4°F~122°F)
Float charging voltage(25°C)		13.60 to 13.80V Temperature compensation: -18mV/°C
Cyclic charging voltage(25°C)		14.50 to 15.00V Temperature compensation: -30mV/°C
Maximum charging current		5.4A
Maximum discharge current		270A(5 sec.)
Designed floating life(20°C)		10 years



LH18-12 12V18Ah

Discharge characteristics(25°C)

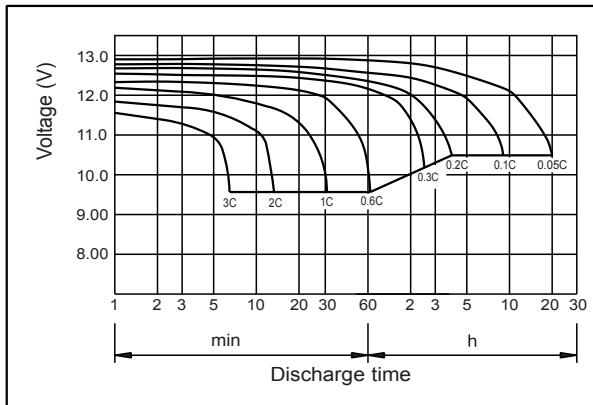

Charging characteristics (25°C)

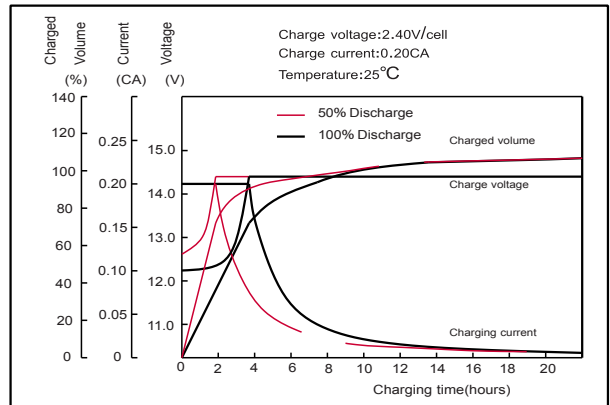

Effect of temperature on capacity

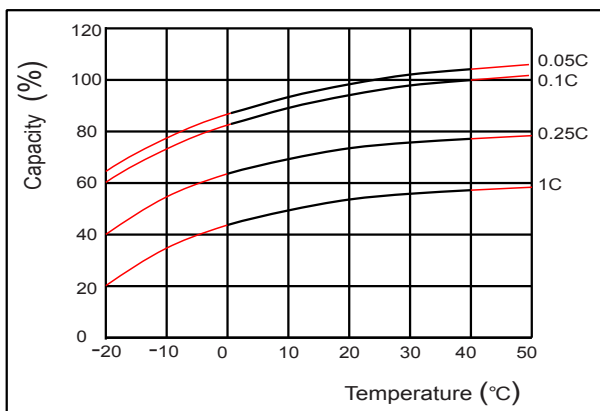

Self-discharge characteristics

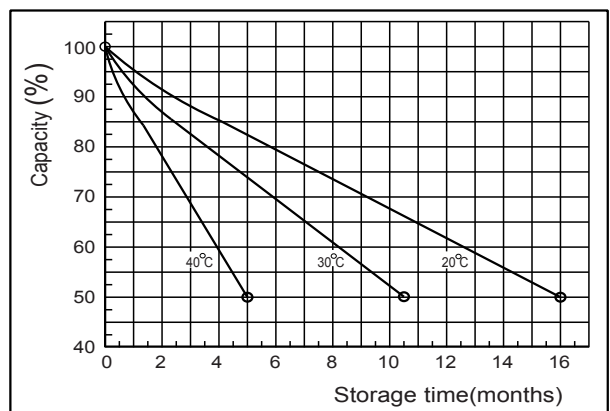

Floating life on temperature

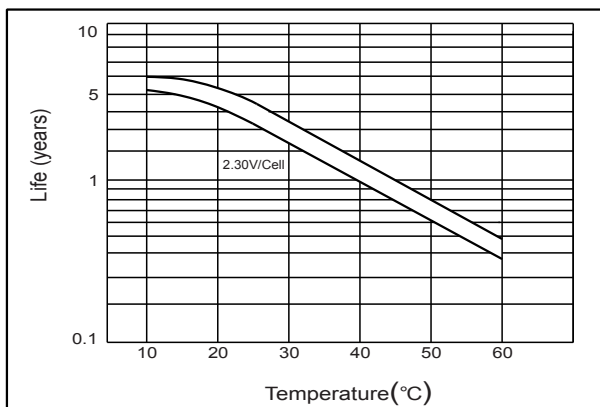

Cycle life on D.O.D(25°C)

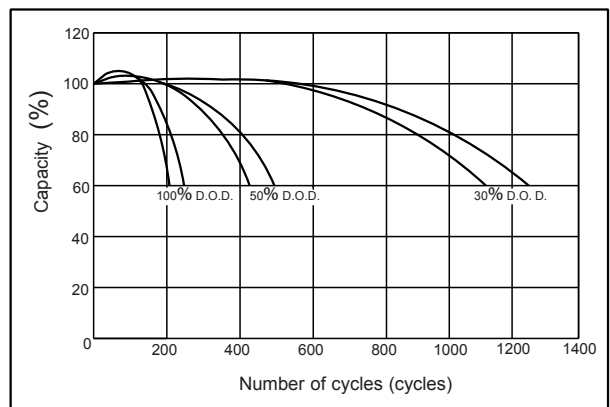

The relationship for OCV and Capacity (25°C)

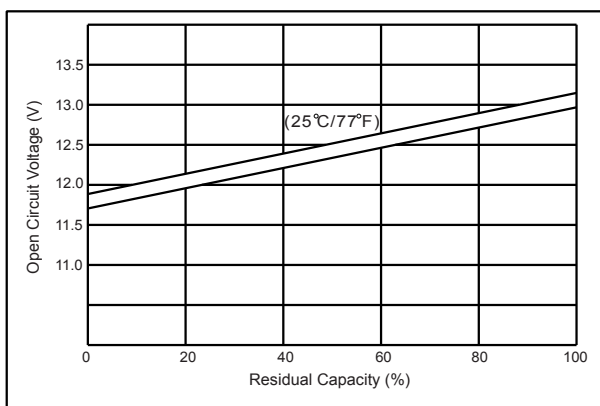

The relationship for Charging voltage and Temperature

